

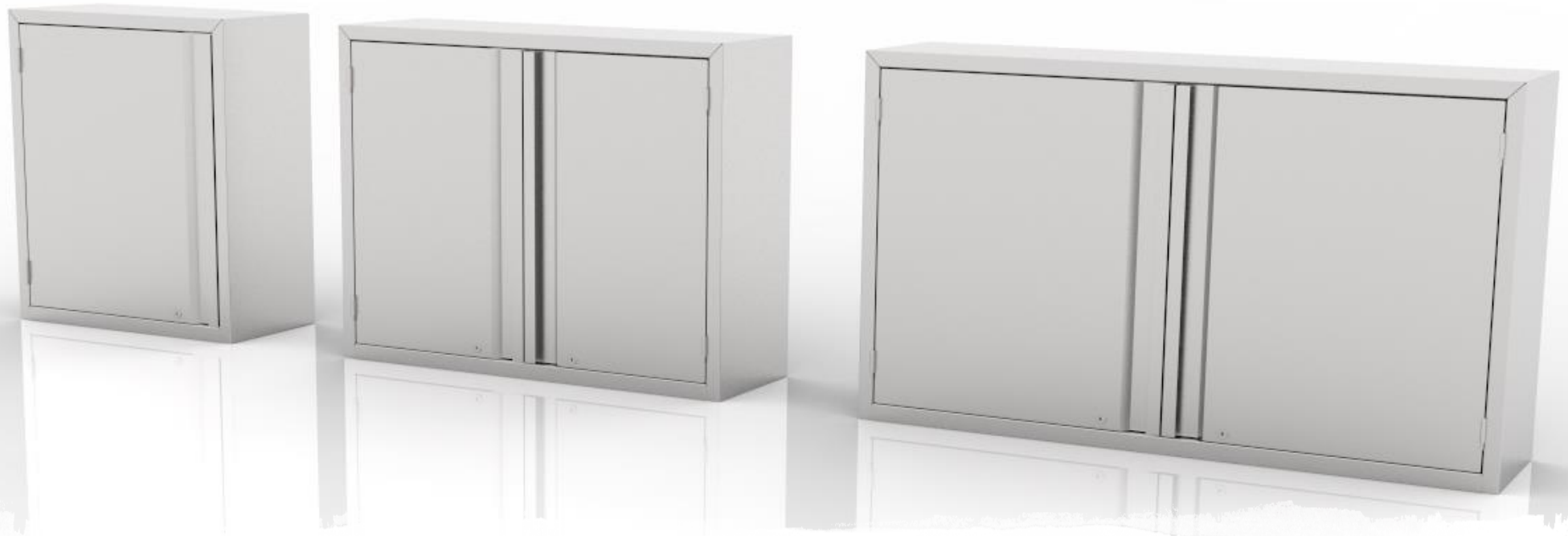

Wall Cupboards

Design Guidelines



Our new wall cupboards have been designed with fully tanked base and sides with a chamfer to the rear base making cleaning easier.

Shine Wall Cupboard Spec

There are 3 different specifications for our units.

Premium:

1.2mm 304 Grade Panels, 700mm High, Folded Handles

Standard:

1.2mm 430 Grade Panels, 700mm High, Inset Handles
Doors

Shine Lite:

1.2mm 430 Grade Panels, 500mm High, Inset Handles



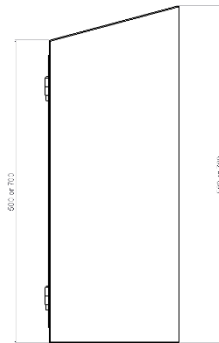
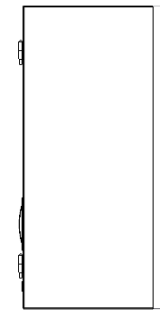
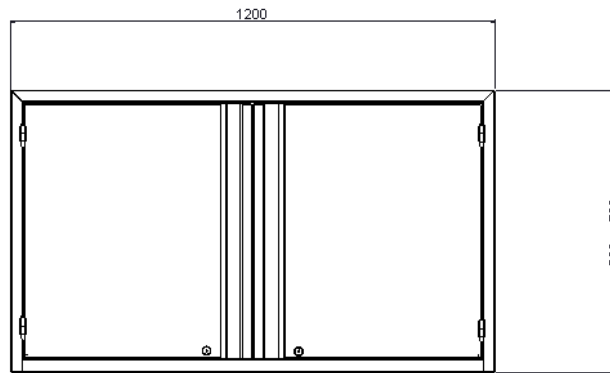
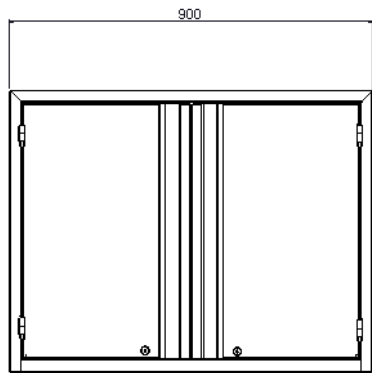
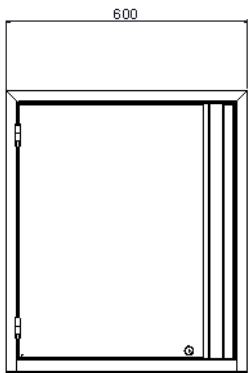
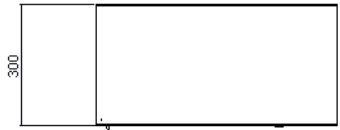

Available in set sizes of: 600, 900, 1200,
bespoke lengths can be made at
additional cost if required.



Folded handles

Premium specification.

Inset Handles

Standard and lite specification.



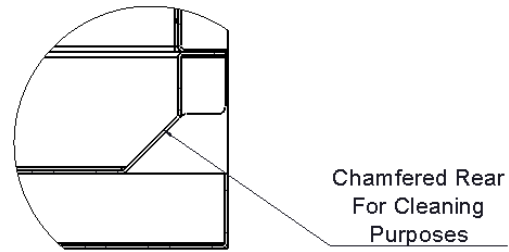

DETAIL C
SCALE 1 : 2

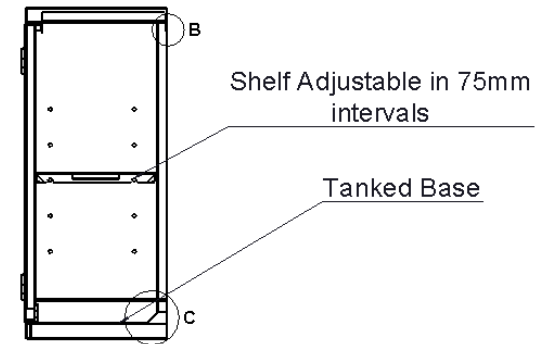

SECTION A-A
SCALE 1 : 10

The joint between base and sides means no raw edges are on show. The rear of the base shelf will be chamfered, providing easier cleaning and maintenance.



All wall cupboards will have a single piece wrap over the sides and top. This allows us to remove any join lines and raw edges.

Looking at the image you can see the wrap highlighted in green.